

5.0 x 3.0 x 0.5 (mm) GNSS L1 & L2 & L5 & L6 Ceramic Chip

Antenna (CB501F) Engineering Specification

1. Product Number

H 2 U J 4 U 1 H 2 Q 0 1 0 0



2. Features

The CB501F can simultaneously receive the following signals:

- *GPS L1/L2/L5
- *BeiDou (BDS) B1/B2/B3
- *QZSS L1/L2/L5/E6
- *GLONASS G1/G2/G3
- *Galileo (GAL) E1/E5/E6
- *IRNSS L5

3. Applications

- * Smartphones
- * Wearables
- * Tablets
- * Digital Cameras

4. Description

The CB501F GNSS ceramic chip antenna supports multi-band simultaneously reception of GPS/GLONASS/BDS/Galileo/QZSS/IRNSS navigations, and as a result, achieves lane-level accuracy outdoors and much higher resistance to multipath and reflected signals in urban scenarios, as well as higher immunity to interference and jamming.



詠業科技股份有限公司
Unictron Technologies Corporation
Website: www.unictron.com

THIS DRAWINGS AND SPECIFICATIONS ARE THE PROPERTY OF UNICTRON TECHNOLOGIES CORPORATION AND SHALL NOT BE REPRODUCED OR USED AS THE BASIS FOR THE MANUFACTURE OR SALE OF APPARATUS OR DEVICES WITHOUT PERMISSION

Prepared by : **Wen** Designed by : **James** Checked by : **Mike** Approved by : **Herbert**

TITLE : 5.0 x 3.0 x 0.5 (mm) GNSS L1 & L2 & L5 & L6 Ceramic Chip Antenna (CB501F) Engineering Specification

DOCUMENT NO.

H2UJ4U1H2Q0100

REV.
C

5. Layout Guide & Electrical Specifications

5-1. Layout Guide (unit : mm)

Solder Land Pattern:

The solder land pattern (gold marking areas) is shown below. Recommendation on matching circuit will be provided according to customer's installation conditions.

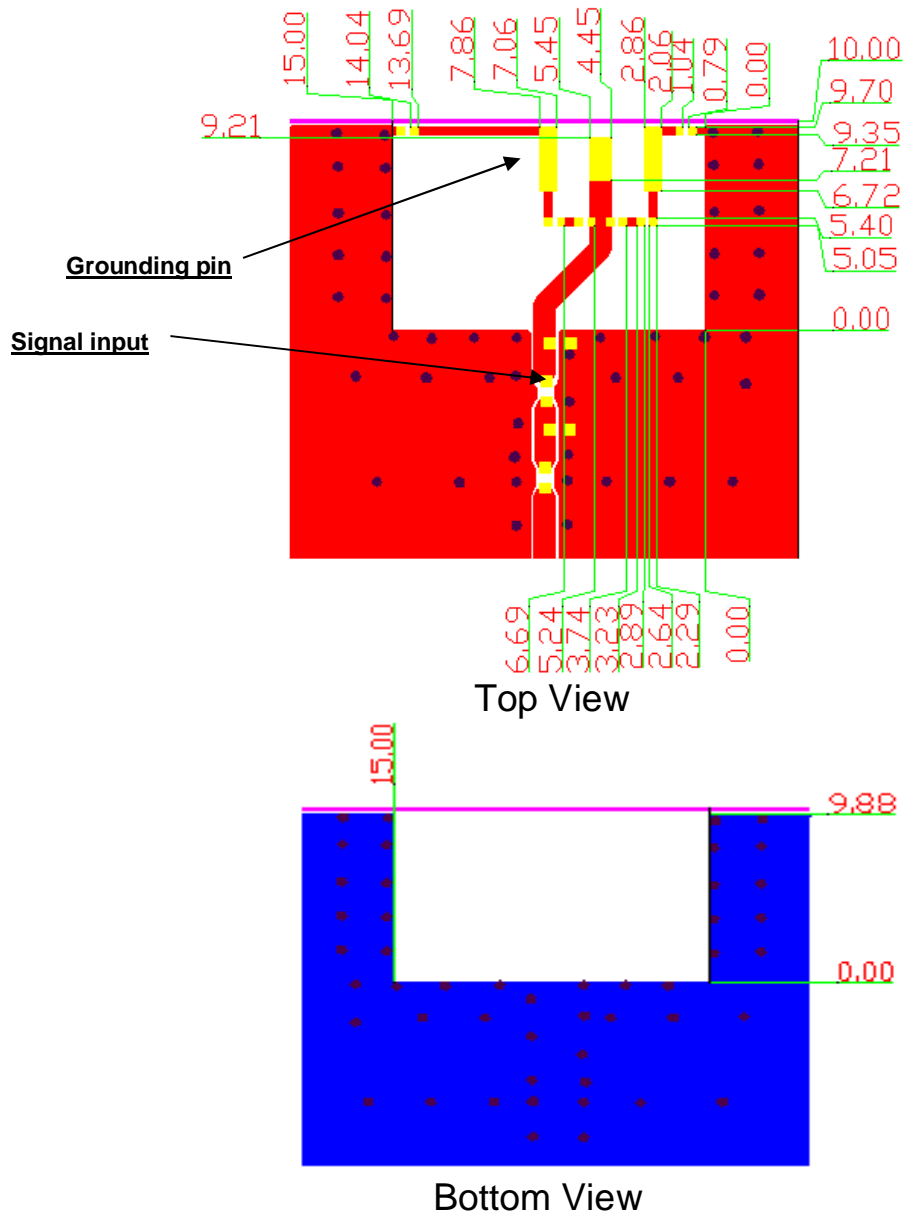

詠業科技股份有限公司
Unictron Technologies Corporation
Website: www.unictron.com

THIS DRAWINGS AND SPECIFICATIONS ARE THE PROPERTY OF UNICTRON TECHNOLOGIES CORPORATION AND SHALL NOT BE REPRODUCED OR USED AS THE BASIS FOR THE MANUFACTURE OR SALE OF APPARATUS OR DEVICES WITHOUT PERMISSION

Prepared by : Wen

Designed by : James

Checked by : Mike

Approved by : Herbert

TITLE : 5.0 x 3.0 x 0.5 (mm) GNSS L1 & L2 & L5 & L6
Ceramic Chip Antenna (CB501F) Engineering
Specification

DOCUMENT
NO.

H2UJ4U1H2Q0100

REV.
C

5-2. Electrical Specifications (Evaluation Board Dimensions: 80 x 40 mm²)

5-2-1. Electrical Table

Specification				
Navigation	GPS L1/ GLONASS G1/ Galileo E1/ BDS B1/ QZSS L1	GPS L2/ GLONASS G2/ QZSS L2	GPS L5/ GLONASS G3/ Galileo E5/ BDS B2/ QZSS L5/ IRNSS L5	Galileo E6/ BDS B3/ QZSS E6
Frequency (MHz)	1575.42	1227.6	1176.45	1278.75
Efficiency (%)	70 Typ.	72 Typ.	70 Typ.	60 Typ.
VSWR	< 2.0			
Impedance (Ω)	50			
Polarization	Linear			
Dimension (mm)	5.0 x 3.0 x 0.5			
Test Condition	80 x 40mm Evaluation Board			



THIS DRAWINGS AND SPECIFICATIONS ARE THE PROPERTY OF UNICTRON TECHNOLOGIES CORPORATION AND SHALL NOT BE REPRODUCED OR USED AS THE BASIS FOR THE MANUFACTURE OR SALE OF APPARATUS OR DEVICES WITHOUT PERMISSION

Prepared by : **Wen** Designed by : **James** Checked by : **Mike** Approved by : **Herbert**

TITLE : 5.0 x 3.0 x 0.5 (mm) GNSS L1 & L2 & L5 & L6
Ceramic Chip Antenna (CB501F) Engineering
Specification

DOCUMENT
NO.

H2UJ4U1H2Q0100

REV.
C

5-2-2. V.S.W.R.

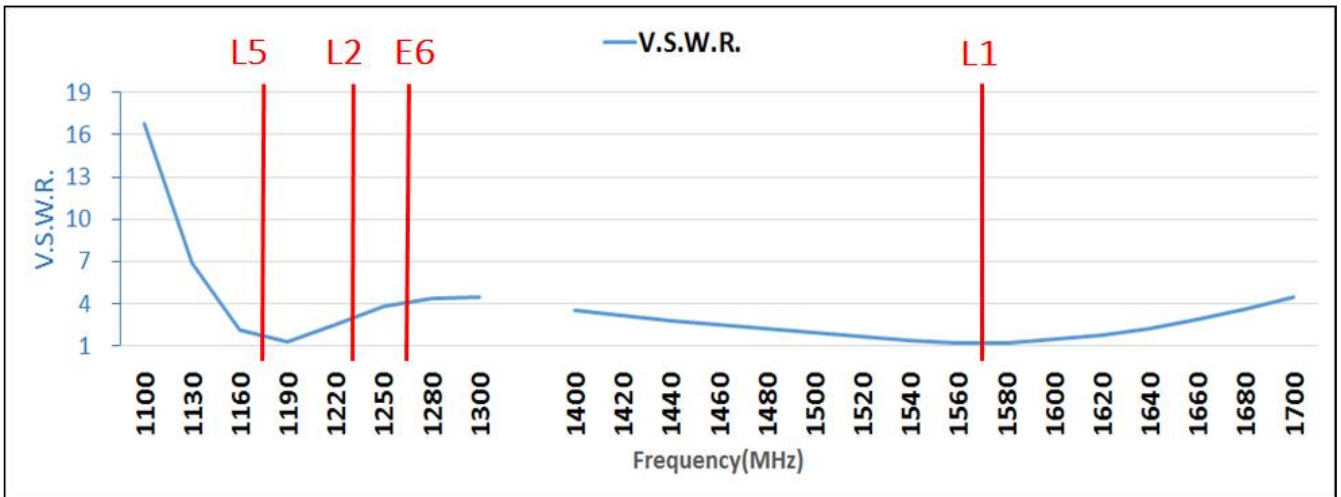

5-2-3. Total radiation average gain

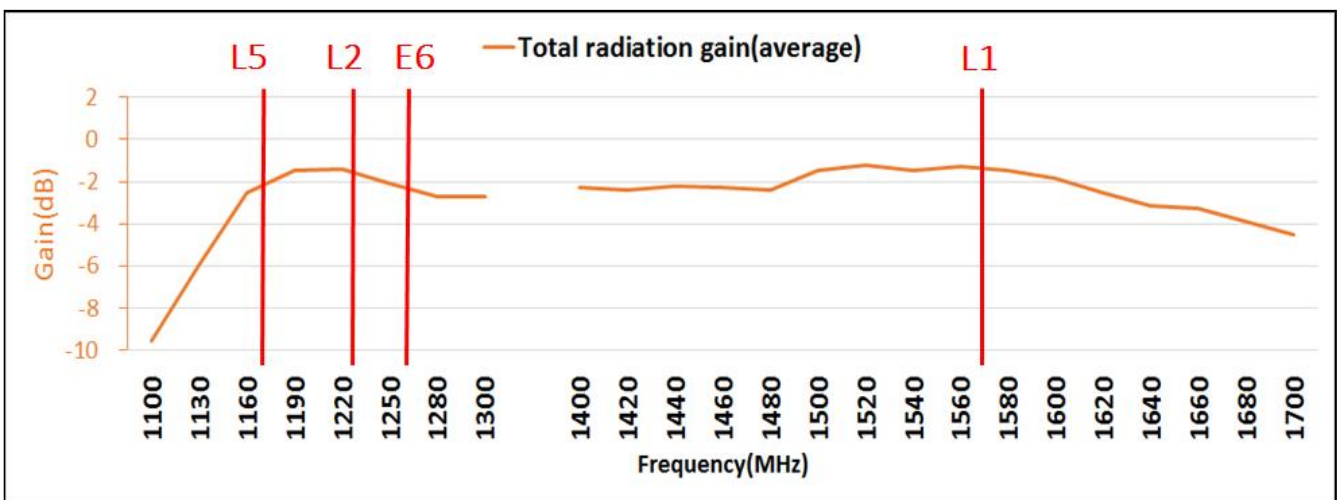

5-2-4. Peak gain

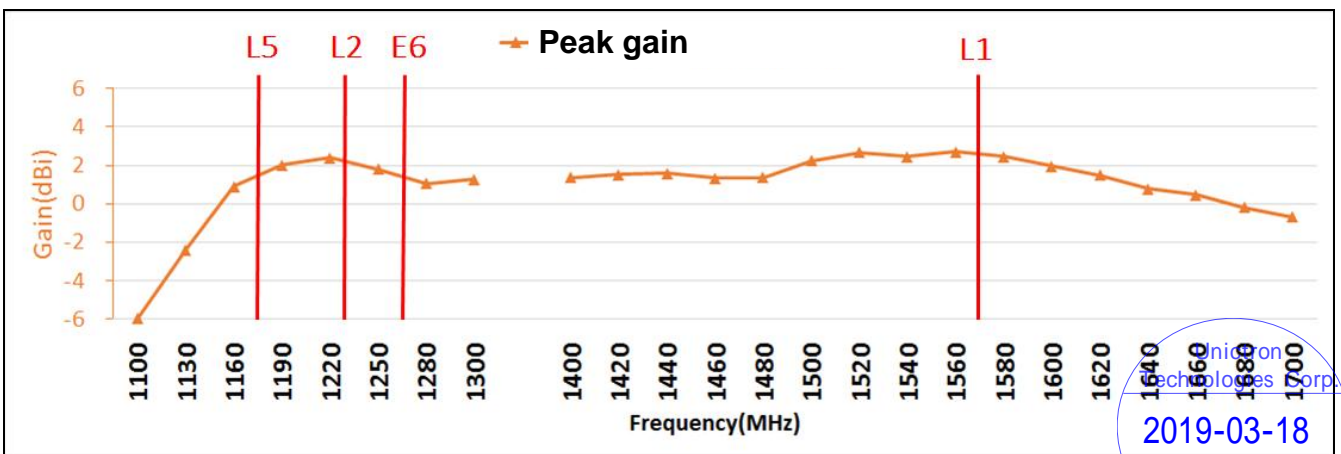

Unictron Technologies Corp.
2019-03-18
Document Control Center



詠業科技股份有限公司
Unictron Technologies Corporation
Website: www.unictron.com

THIS DRAWINGS AND SPECIFICATIONS ARE THE PROPERTY OF UNICTRON TECHNOLOGIES CORPORATION AND SHALL NOT BE REPRODUCED OR USED AS THE BASIS FOR THE MANUFACTURE OR SALE OF APPARATUS OR DEVICES WITHOUT PERMISSION

Prepared by : Wen

Designed by : James

Checked by : Mike

Approved by : Herbert

TITLE : 5.0 x 3.0 x 0.5 (mm) GNSS L1 & L2 & L5 & L6 Ceramic Chip Antenna (CB501F) Engineering Specification

DOCUMENT NO.

H2UJ4U1H2Q0100

REV. C

6. Outline Dimensions of Antenna & Evaluation Board (unit: mm)

6.1. Antenna Dimension

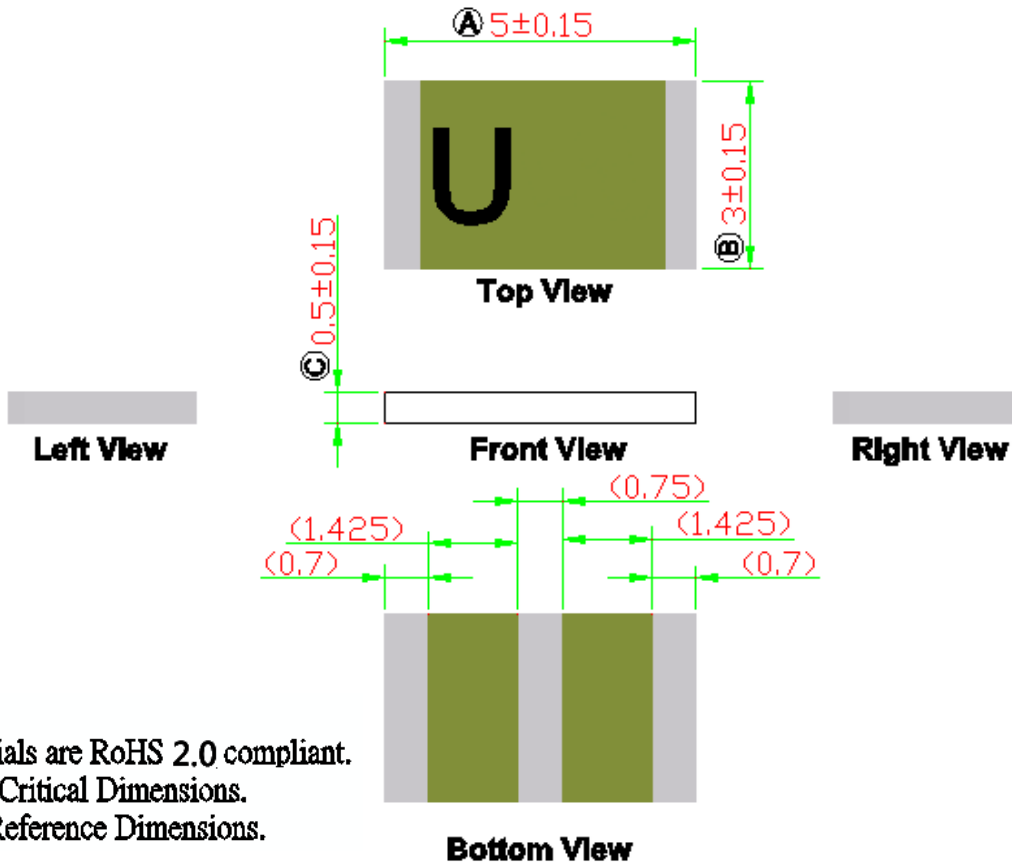

NOTE:

1. All materials are RoHS 2.0 compliant.
2. "A~C" Critical Dimensions.
3. "()" Reference Dimensions.

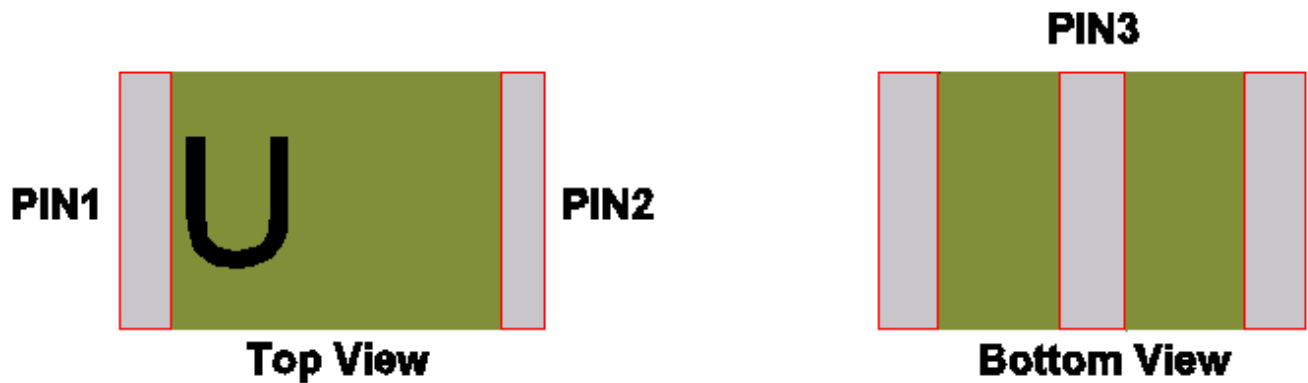

PIN	1	2	3
Soldering Pad	Tuning / Ground	Tuning / Ground	Signal



詠業科技股份有限公司
Unictron Technologies Corporation
Website: www.unictron.com

THIS DRAWINGS AND SPECIFICATIONS ARE THE PROPERTY OF UNICTRON TECHNOLOGIES CORPORATION AND SHALL NOT BE REPRODUCED OR USED AS THE BASIS FOR THE MANUFACTURE OR SALE OF APPARATUS OR DEVICES WITHOUT PERMISSION

Prepared by : **Wen** Designed by : **James** Checked by : **Mike** Approved by : **Herbert**

TITLE : 5.0 x 3.0 x 0.5 (mm) GNSS L1 & L2 & L5 & L6 Ceramic Chip Antenna (CB501F) Engineering Specification

DOCUMENT NO.

H2UJ4U1H2Q0100

REV.
C

6.2. Evaluation Board with Antenna

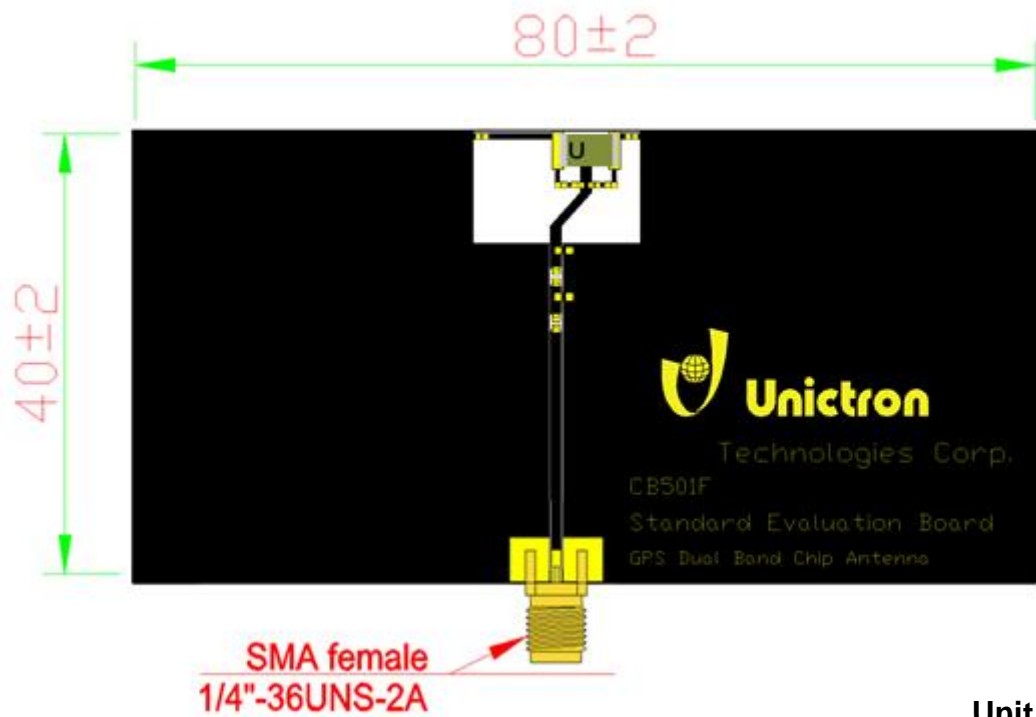

Unit: mm



詠業科技股份有限公司
 Unictron Technologies Corporation
 Website: www.unictron.com

THIS DRAWINGS AND SPECIFICATIONS ARE THE
 PROPERTY OF UNICTRON TECHNOLOGIES
 CORPORATION AND SHALL NOT BE REPRODUCED
 OR USED AS THE BASIS FOR THE MANUFACTURE OR
 SALE OF APPARATUS OR DEVICES WITHOUT
 PERMISSION

Prepared by : **Wen**

Designed by : **James**

Checked by : **Mike**

Approved by : **Herbert**

TITLE : 5.0 x 3.0 x 0.5 (mm) GNSS L1 & L2 & L5 & L6
Ceramic Chip Antenna (CB501F) Engineering
Specification

DOCUMENT
NO.

H2UJ4U1H2Q0100

REV.

C

7. 3D Radiation Gain Pattern

7-1. 3D Gain Pattern @ 1176.45 MHz (unit: dBi)

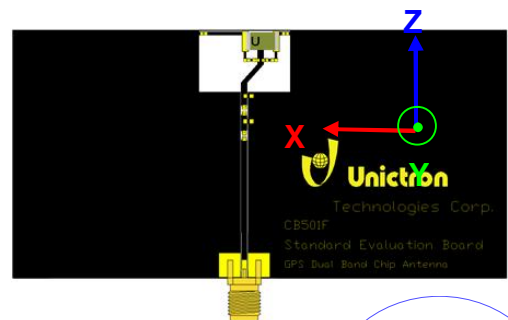
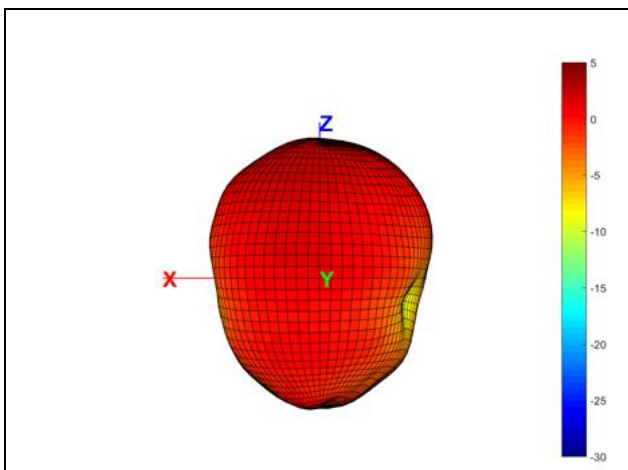
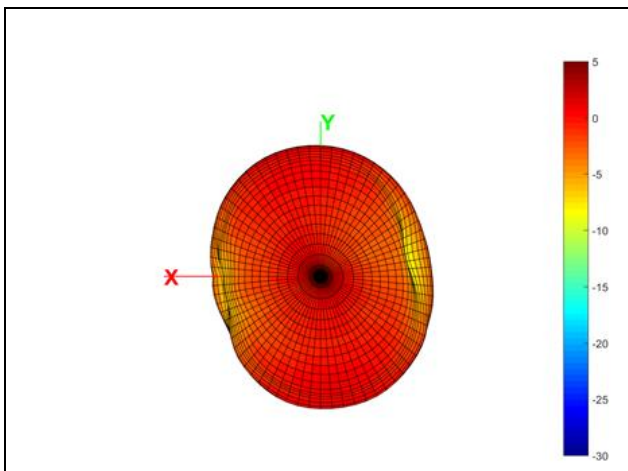
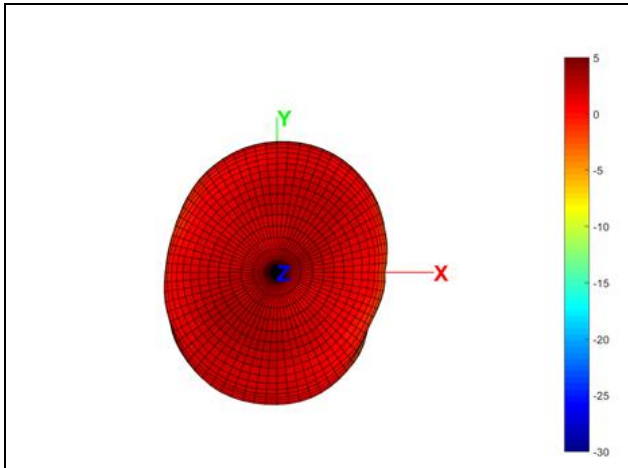

Unicon Technologies Corp.
2019-03-18
Document Control Center



詠業科技股份有限公司
Unicon Technologies Corporation
Website: www.unicon.com

THIS DRAWINGS AND SPECIFICATIONS ARE THE PROPERTY OF UNICON TECHNOLOGIES CORPORATION AND SHALL NOT BE REPRODUCED OR USED AS THE BASIS FOR THE MANUFACTURE OR SALE OF APPARATUS OR DEVICES WITHOUT PERMISSION

Prepared by : Wen

Designed by : James

Checked by : Mike

Approved by : Herbert

TITLE : 5.0 x 3.0 x 0.5 (mm) GNSS L1 & L2 & L5 & L6 Ceramic Chip Antenna (CB501F) Engineering Specification

DOCUMENT NO.

H2UJ4U1H2Q0100

REV. C

7-2. 3D Gain Pattern @ 1227.6MHz (unit: dBi)

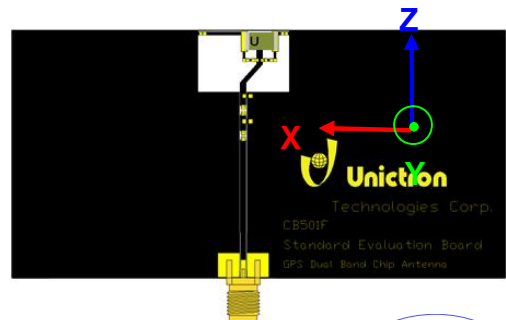
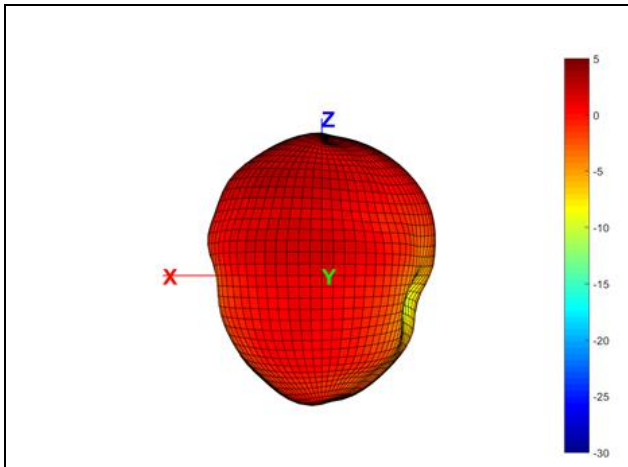
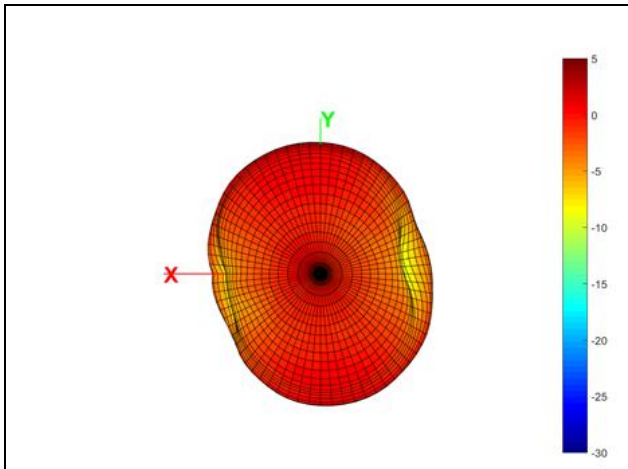
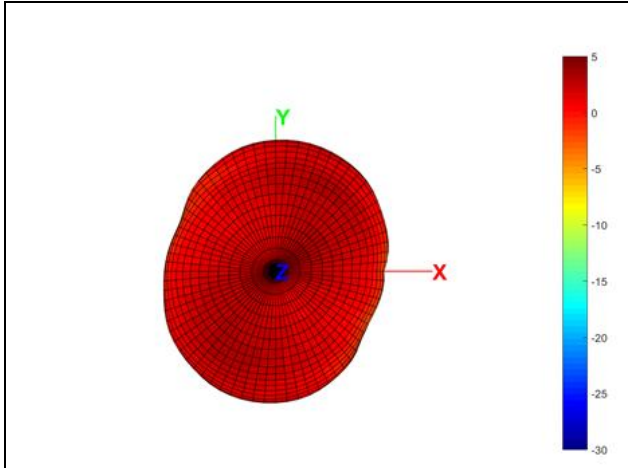

Unicon
Technologies Corp.
2019-03-18
Document
Control Center



詠業科技股份有限公司
Unicon Technologies Corporation
Website: www.unicon.com

THIS DRAWINGS AND SPECIFICATIONS ARE THE PROPERTY OF UNICON TECHNOLOGIES CORPORATION AND SHALL NOT BE REPRODUCED OR USED AS THE BASIS FOR THE MANUFACTURE OR SALE OF APPARATUS OR DEVICES WITHOUT PERMISSION

Prepared by : Wen

Designed by : James

Checked by : Mike

Approved by : Herbert

TITLE : 5.0 x 3.0 x 0.5 (mm) GNSS L1 & L2 & L5 & L6
Ceramic Chip Antenna (CB501F) Engineering
Specification

DOCUMENT
NO.

H2UJ4U1H2Q0100

REV.
C

7-3. 3D Gain Pattern @ 1278.45MHz (unit: dBi)

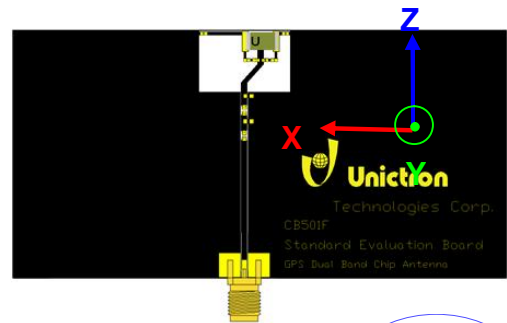
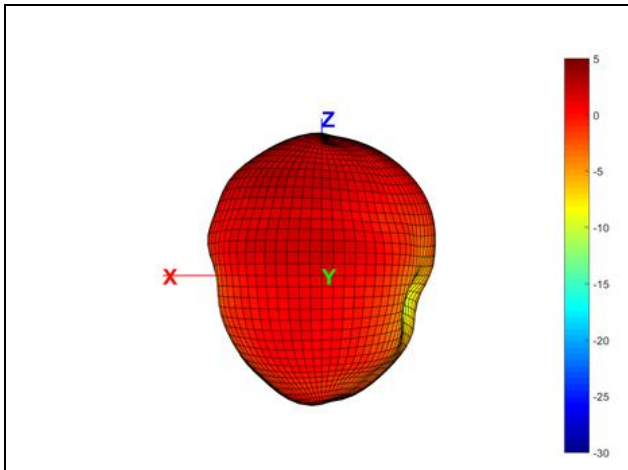
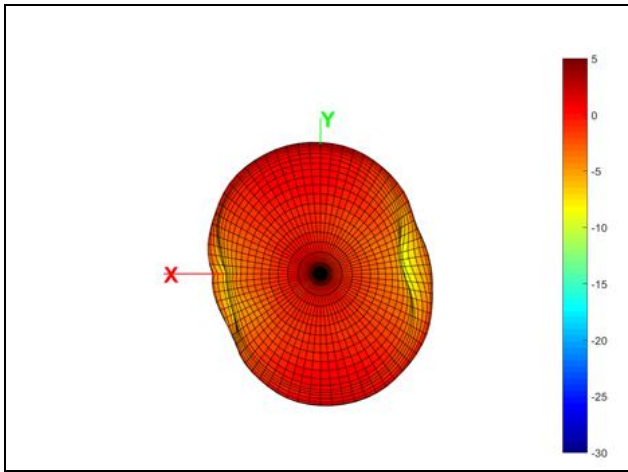
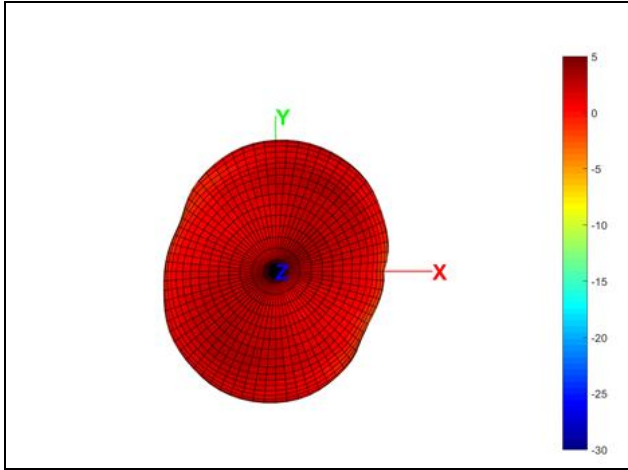

Unicon Technologies Corp.
2019-03-18
Document Control Center



詠業科技股份有限公司
Unicon Technologies Corporation
Website: www.unicon.com

THIS DRAWINGS AND SPECIFICATIONS ARE THE PROPERTY OF UNICON TECHNOLOGIES CORPORATION AND SHALL NOT BE REPRODUCED OR USED AS THE BASIS FOR THE MANUFACTURE OR SALE OF APPARATUS OR DEVICES WITHOUT PERMISSION

Prepared by : Wen

Designed by : James

Checked by : Mike

Approved by : Herbert

TITLE : 5.0 x 3.0 x 0.5 (mm) GNSS L1 & L2 & L5 & L6 Ceramic Chip Antenna (CB501F) Engineering Specification

DOCUMENT NO.

H2UJ4U1H2Q0100

REV. C

7-4. 3D Gain Pattern @ 1575.42 MHz (unit: dBi)

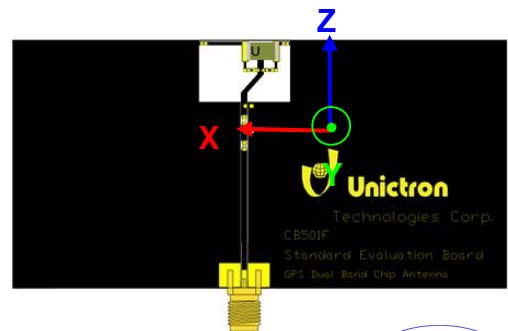
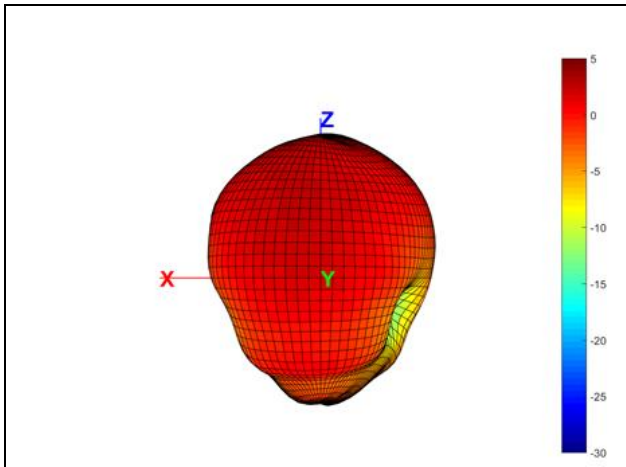
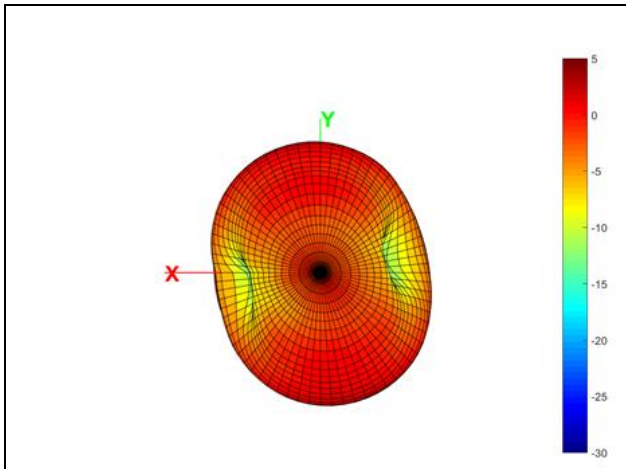
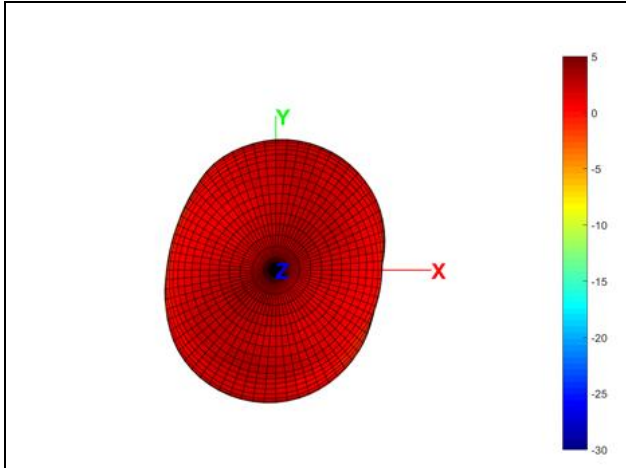

Unictron
Technologies Corp.
2019-03-18
Document
Control Center



詠業科技股份有限公司
Unictron Technologies Corporation
Website: www.unictron.com

THIS DRAWINGS AND SPECIFICATIONS ARE THE PROPERTY OF UNICTRON TECHNOLOGIES CORPORATION AND SHALL NOT BE REPRODUCED OR USED AS THE BASIS FOR THE MANUFACTURE OR SALE OF APPARATUS OR DEVICES WITHOUT PERMISSION

Prepared by : Wen

Designed by : James

Checked by : Mike

Approved by : Herbert

TITLE : 5.0 x 3.0 x 0.5 (mm) GNSS L1 & L2 & L5 & L6
Ceramic Chip Antenna (CB501F) Engineering
Specification

DOCUMENT
NO.

H2UJ4U1H2Q0100

REV.
C

8. Frequency Tuning and Matching Circuit

8-1. Chip antenna tuning scenario :

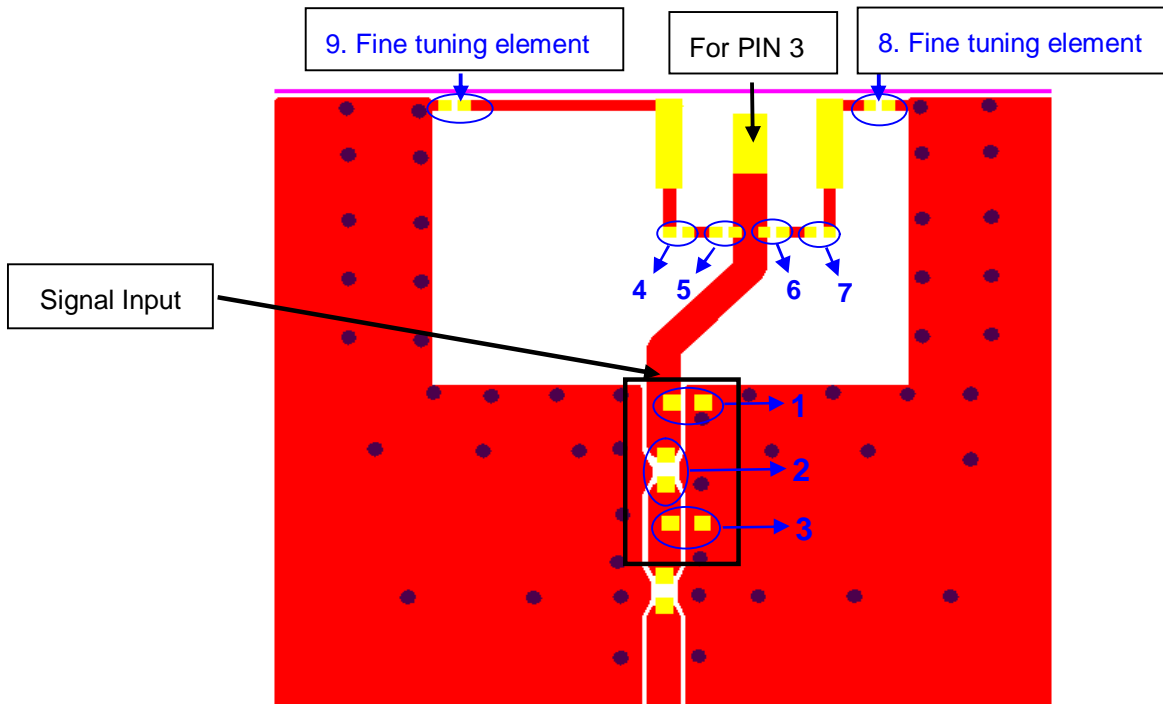

8-2. Matching circuit :

With the following recommended values of matching and tuning components, the center frequencies will be about 1176.45MHz and 1575.42MHz at our standard 80x40 mm² evaluation board. However, these are typical reference values which may need to be changed when circuit boards or part vendors are different.

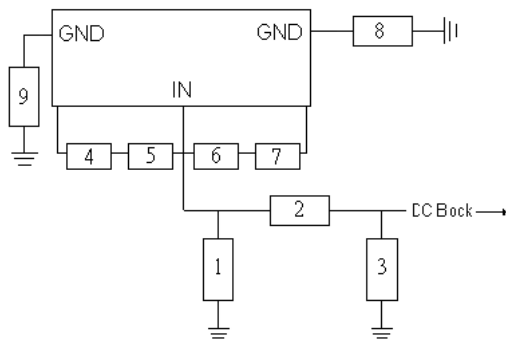

System Matching Circuit Component			
Location	Description	Vendor	Tolerance
1	1.5pF, (0402)	Murata	±0.05pF
2	3.6pF, (0402)	Murata	±0.1pF
3	N/A	-	-
4~7 Fine tuning element	NA	-	-
8 Fine tuning element	2.7 pF, (0201)	Murata	±0.1pF
9 Fine tuning element	6.8 pF, (0201)	Murata	±0.1pF



詠業科技股份有限公司
Unictron Technologies Corporation
Website: www.unictron.com

THIS DRAWINGS AND SPECIFICATIONS ARE THE PROPERTY OF UNICTRON TECHNOLOGIES CORPORATION AND SHALL NOT BE REPRODUCED OR USED AS THE BASIS FOR THE MANUFACTURE OR SALE OF APPARATUS OR DEVICES WITHOUT PERMISSION

Prepared by : Wen

Designed by : James

Checked by : Mike

Approved by : Herbert

TITLE : 5.0 x 3.0 x 0.5 (mm) GNSS L1 & L2 & L5 & L6
Ceramic Chip Antenna (CB501F) Engineering
Specification

DOCUMENT
NO.

H2UJ4U1H2Q0100

REV.
C

9. Soldering Conditions

Typical Soldering Profile for Lead-free Process

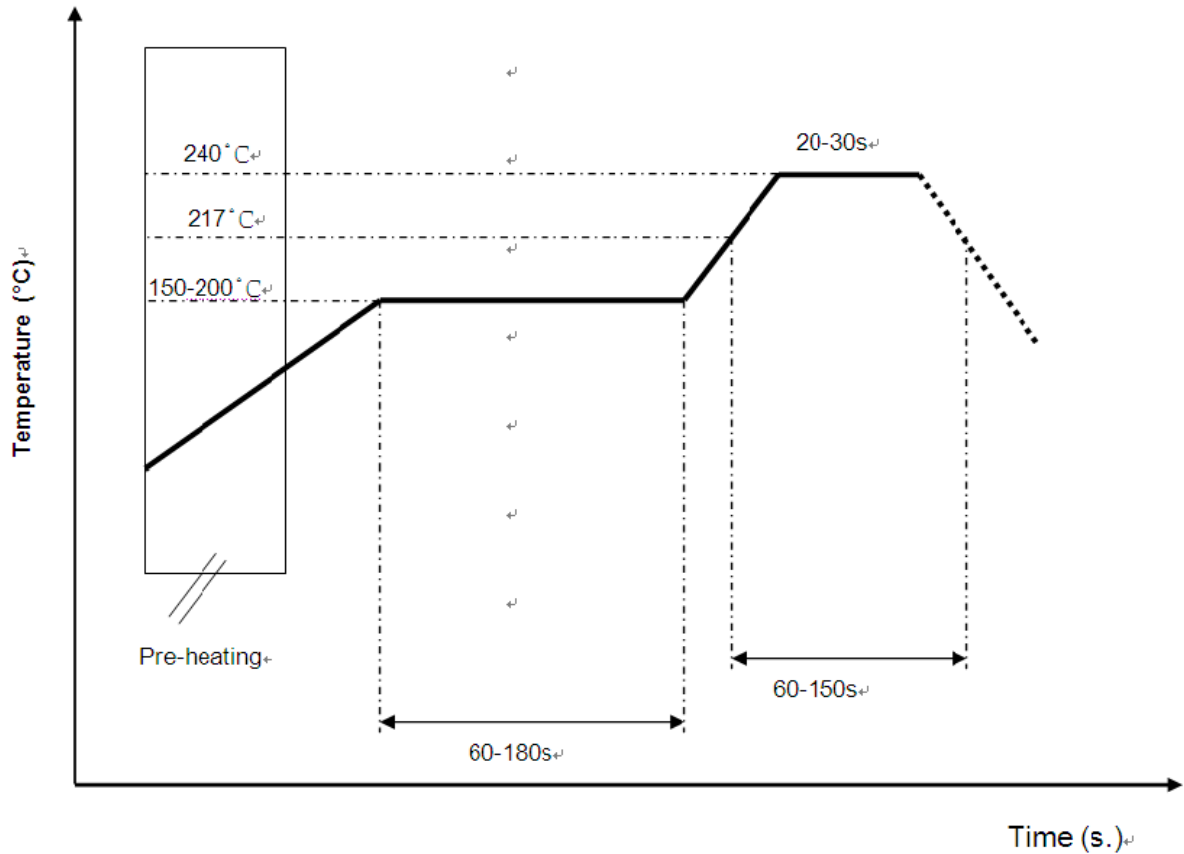

* Recommended solder paste alloy: SAC305 (Sn96.5 /Ag3 /Cu0.5) Lead Free solder paste



詠業科技股份有限公司
Unictron Technologies Corporation
Website: www.unictron.com

THIS DRAWINGS AND SPECIFICATIONS ARE THE PROPERTY OF UNICTRON TECHNOLOGIES CORPORATION AND SHALL NOT BE REPRODUCED OR USED AS THE BASIS FOR THE MANUFACTURE OR SALE OF APPARATUS OR DEVICES WITHOUT PERMISSION

Prepared by : **Wen**

Designed by : **James**

Checked by : **Mike**

Approved by : **Herbert**

TITLE : 5.0 x 3.0 x 0.5 (mm) GNSS L1 & L2 & L5 & L6 Ceramic Chip Antenna (CB501F) Engineering Specification

DOCUMENT NO.

H2UJ4U1H2Q0100

REV.

C

10. Reminders for users of Unictron's CB501F ceramic chip antennas

- 10-1. This chip antenna is made of ceramic materials which is relatively more rigid and brittle compared to circuit board materials. Furthermore, the length of this antenna is quite long. Bending of circuit board at the locations where chip antenna is mounted may cause the cracking of solder joints or antenna itself.
- 10-2. Punching/cutting of the break-off tab of PCB panel may cause severe bending of the circuit board which may result in cracking of solder joints or chip antenna itself. Therefore break-off tab shall be located away from the installation site of chip antenna.
- 10-3. Be cautious when ultrasonic welding process needs to be used near the locations where chip antennas are installed. Strong ultrasonic vibration may cause the cracking of chip antenna solder joints.

11. Packing

- (1) Quantity/Reel: 6000 pcs/Reel
- (2) Plastic tape:

a. Tape Drawing

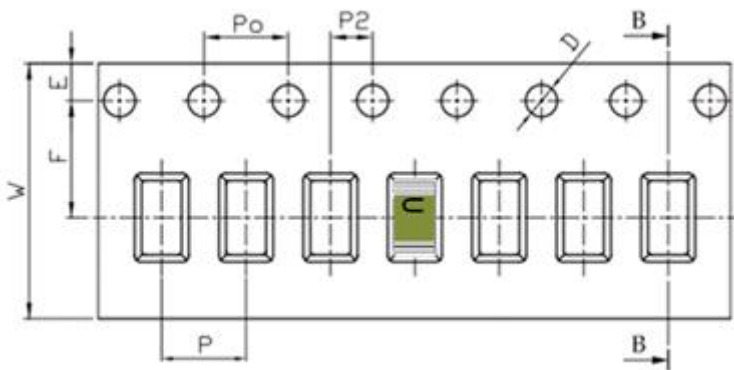

b. Tape Dimensions (unit: mm)

Feature	Specifications	Tolerances
W	12.00	±0.30
P	8.00	±0.10
E	1.75	±0.10
F	5.50	±0.10
P2	2.00	±0.10
D	1.50	+0.10 -0.00
P0	4.00	±0.10
10P0	40.00	±0.20



詠業科技股份有限公司
Unictron Technologies Corporation
Website: www.unictron.com

THIS DRAWINGS AND SPECIFICATIONS ARE THE PROPERTY OF UNICTRON TECHNOLOGIES CORPORATION AND SHALL NOT BE REPRODUCED OR USED AS THE BASIS FOR THE MANUFACTURE OR SALE OF APPARATUS OR DEVICES WITHOUT PERMISSION

Prepared by : Wen

Designed by : James

Checked by : Mike

Approved by : Herbert

TITLE : 5.0 x 3.0 x 0.5 (mm) GNSS L1 & L2 & L5 & L6
Ceramic Chip Antenna (CB501F) Engineering
Specification

DOCUMENT
NO.

H2UJ4U1H2Q0100

REV.
C

12. Operating & Storage Conditions

12-1. Operating

- (1) Maximum Input Power: 2 W
- (2) Operating Temperature: -40°C to 85°C
- (3) Relative Humidity: 10% to 70%

12-2. Storage (sealed)

- (1) Storage Temperature: -5°C to 40°C
- (2) Relative Humidity: 20% to 70%
- (3) Shelf Life: 1 year

12-3. Storage (unsealed)

Meet the criteria of J-STD-033 MSL2a

12-4. Storage (After mounted on customer's PCB with SMT process)

- (1) Storage Temperature: -40°C to 85°C
- (2) Relative Humidity: 10% to 70%

13. Notice

(1) Installation Guide:

Please refer to Unictron's application note "General guidelines for the installation of Unictron's chip antennas" for further information.

(2) All specifications are subject to change without notice.



詠業科技股份有限公司
Unictron Technologies Corporation
Website: www.unictron.com

THIS DRAWINGS AND SPECIFICATIONS ARE THE PROPERTY OF UNICTRON TECHNOLOGIES CORPORATION AND SHALL NOT BE REPRODUCED OR USED AS THE BASIS FOR THE MANUFACTURE OR SALE OF APPARATUS OR DEVICES WITHOUT PERMISSION

Prepared by : **Wen**

Designed by : **James**

Checked by : **Mike**

Approved by : **Herbert**

TITLE : 5.0 x 3.0 x 0.5 (mm) GNSS L1 & L2 & L5 & L6
Ceramic Chip Antenna (CB501F) Engineering
Specification

**DOCUMENT
NO.**

H2UJ4U1H2Q0100

**REV.
C**